













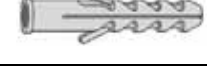











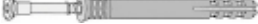

















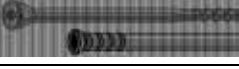





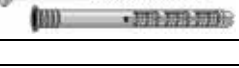





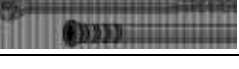



PRODUCTS



















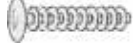
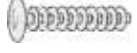

2008









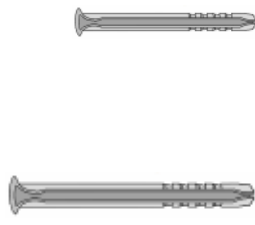

| art.-no. | article | size | box | overcarton | remarks |
|----------|--|------|-----|------------|---------|
| 10 000 | Nylon - Plug "BEST"   | 4 | 100 | 12.800 | |
| | | 5 | 100 | 12.800 | |
| | | 6 | 100 | 12.800 | |
| | | 7 | 100 | 6.400 | |
| | | 8 | 100 | 6.400 | |
| | | 10 | 50 | 3.200 | |
| | | 12 | 25 | 1.600 | |
| | | 14 | 20 | 1.280 | |
| 10 100 | Plastic-Plug "BEST"  | 5 | 100 | 12.800 | |
| | | 6 | 100 | 12.800 | |
| | | 8 | 100 | 6.400 | |
| | | 10 | 50 | 3.200 | |
| | | 12 | 25 | 1.600 | |
| | | 14 | 20 | 1.280 | |
| 10 050 | Nylon - Plug "BEST" with flange   | 5 | 100 | 12.800 | |
| | | 6 | 100 | 12.800 | |
| | | 8 | 100 | 6.400 | |
| | | 10 | 50 | 3.200 | |
| | | 12 | 25 | 1.600 | |
| | | 14 | 20 | 1.280 | |
| 10 150 | Plastic-Plug "BEST" with flange  | 5 | 100 | 12.800 | |
| | | 6 | 100 | 12.800 | |
| | | 8 | 100 | 6.400 | |
| | | 10 | 50 | 3.200 | |
| | | 12 | 25 | 1.600 | |
| 10 200 | Universalplug "PLUS" without flange  | 6 | 100 | 6.400 | |
| | | 8 | 100 | 4.000 | |
| | | 10 | 50 | 2.000 | |
| 10 250 | Universalplug "PLUS" with flange  | 6 | 100 | 6.400 | |
| | | 8 | 100 | 4.000 | |
| | | 10 | 50 | 2.000 | |
| 10 300 | Universalplug "UNIVERS" without flange red or grey   xxxxxx please mention the required color xxxxxx | 5 | 100 | 12.800 | |
| | | 6 | 100 | 6.400 | |
| | | 8 | 100 | 4.000 | |
| | | 10 | 50 | 2.000 | |
| | | 12 | 25 | 1.600 | |
| | | 14 | 20 | 1.280 | |
| 10 350 | Universalplug "UNIVERS" with flange - red or grey   xxxxxx please mention the required color xxxxxx | 5 | 100 | 12.800 | |
| | | 6 | 100 | 6.400 | |
| | | 8 | 100 | 4.000 | |
| | | 10 | 50 | 2.000 | |
| | | 12 | 25 | 1.600 | |
| | | 14 | 20 | 1.280 | |

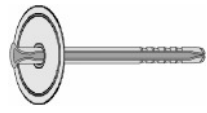
| | | | | | | |
|---------------------|---|---|---------|-----|-------|--|
| 11 000 | Screw-nail-anchor "FIX" anchor with countersunk head  |  | 5 x 30 | 200 | 2.000 | |
| | | | 5 x 35 | 200 | 2.000 | |
| | | | 5 x 40 | 200 | 2.000 | |
| | | | 5 x 50 | 200 | 2.000 | |
| | | | 5 x 60 | 200 | 2.000 | |
| | | | 6 x 30 | 200 | 2.000 | |
| | | | 6 x 35 | 200 | 2.000 | |
| | | | 6 x 40 | 200 | 2.000 | |
| | | | 6 x 50 | 200 | 2.000 | |
| | | | 6 x 60 | 200 | 2.000 | |
| | | | 6 x 80 | 200 | 2.000 | |
| | | | 8 x 50 | 100 | 1.000 | |
| | | | 8 x 60 | 100 | 1.000 | |
| | | | 8 x 80 | 100 | 1.000 | |
| | | | 8 x 100 | 100 | 1.000 | |
| 8 x 120 | 100 | 1.000 | | | | |
| 8 x 140 | 100 | 1.000 | | | | |
| 8 x 160 | 100 | 500 | | | | |
| 11 050 | Screw-nail-anchor "FIX" anchor with cylindrical head  |  | 5 x 30 | 200 | 2.000 | |
| | | | 5 x 35 | 200 | 2.000 | |
| | | | 5 x 40 | 200 | 2.000 | |
| | | | 5 x 50 | 200 | 2.000 | |
| | | | 5 x 60 | 200 | 2.000 | |
| | | | 6 x 30 | 200 | 2.000 | |
| | | | 6 x 35 | 200 | 2.000 | |
| | | | 6 x 40 | 200 | 2.000 | |
| | | | 6 x 50 | 200 | 2.000 | |
| | | | 6 x 60 | 200 | 2.000 | |
| | | | 6 x 80 | 200 | 2.000 | |
| | | | 8 x 50 | 100 | 1.000 | |
| | | | 8 x 60 | 100 | 1.000 | |
| | | | 8 x 80 | 100 | 1.000 | |
| | | | 8 x 100 | 100 | 1.000 | |
| 8 x 120 | 100 | 1.000 | | | | |
| 11 100 | Screw-nail-anchor "FIX COLOR" brass plated  |  | 5 x 30 | 200 | 2.000 | |
| | | | 5 x 40 | 200 | 2.000 | |
| | | | 5 x 50 | 200 | 2.000 | |
| | | | 5 x 60 | 200 | 2.000 | |
| brass plated | | | | | | |
| 11 120 | Screw-nail-anchor "FIX COLOR" white colored  |  | 5 x 30 | 200 | 2.000 | |
| | | | 5 x 40 | 200 | 2.000 | |
| | | | 5 x 50 | 200 | 2.000 | |
| | | | 5 x 60 | 200 | 2.000 | |
| white | | | | | | |
| 11 140 | Screw-nail-anchor "FIX COLOR" grey colored  |  | 5 x 30 | 200 | 2.000 | |
| | | | 5 x 40 | 200 | 2.000 | |
| | | | 5 x 50 | 200 | 2.000 | |
| | | | 5 x 60 | 200 | 2.000 | |
| grey | | | | | | |
| 11 160 | Screw-nail-anchor "FIX COLOR" brown colored  |  | 5 x 30 | 200 | 2.000 | |
| | | | 5 x 40 | 200 | 2.000 | |
| | | | 5 x 50 | 200 | 2.000 | |
| | | | 5 x 60 | 200 | 2.000 | |
| brown | | | | | | |
| 11 070 | Screw-nail-anchor "FIX-S" with zinc plated washer Ø 20 mm  |  | 6 x 35 | 100 | 1.000 | |
| | | | 6 x 40 | 100 | 1.000 | |
| | | | 6 x 50 | 100 | 1.000 | |
| | | | 6 x 60 | 100 | 1.000 | |
| | | | 6 x 80 | 100 | 1.000 | |
| | | | 8 x 50 | 100 | 1.000 | |
| 11 060 | Screw-nail-anchor "FIX-Flange" not pre-assembled  |  | 8 x 45 | 100 | 1.000 | |

| | | | | | | |
|--------|--|----------|----|-----|-------|--|
| 11 200 | Frame-anchor "RKP" with Pozi-screw, zinc plated   | 10 x 80 | 50 | 500 | | |
| | | 10 x 100 | 50 | 500 | | |
| | | 10 x 120 | 50 | 500 | | |
| | | 10 x 140 | 50 | 500 | | |
| | | 10 x 160 | 50 | 500 | | |
| 11 205 | Frame-anchor "RKPF" with Pozi-screw, hot galvanized   | 10 x 80 | 50 | 500 | | |
| | | 10 x 100 | 50 | 500 | | |
| | | 10 x 120 | 50 | 500 | | |
| | | 10 x 140 | 50 | 500 | | |
| | | 10 x 160 | 50 | 500 | | |
| 11 210 | Frame-anchor "RKT" with Star-screw, zinc plated   | 10 x 80 | 50 | 500 | | |
| | | 10 x 100 | 50 | 500 | | |
| | | 10 x 120 | 50 | 500 | | |
| | | 10 x 140 | 50 | 500 | | |
| | | 10 x 160 | 50 | 500 | | |
| 11 215 | Frame-anchor "RKTf" with Star-screw, hot galvanized   | 10 x 80 | 50 | 500 | | |
| | | 10 x 100 | 50 | 500 | | |
| | | 10 x 120 | 50 | 500 | | |
| | | 10 x 140 | 50 | 500 | | |
| | | 10 x 160 | 50 | 500 | | |
| 11 220 | Frame-anchor "RKS" with hex-head screw, zinc plated   | 10 x 80 | 50 | 500 | | |
| | | 10 x 100 | 50 | 500 | | |
| | | 10 x 120 | 50 | 500 | | |
| | | 10 x 140 | 50 | 500 | | |
| | | 10 x 160 | 50 | 500 | | |
| 11 225 | Frame-anchor "RKSF" with hex-head screw, hot galvanized   | 10 x 80 | 50 | 500 | | |
| | | 10 x 100 | 50 | 500 | | |
| | | 10 x 120 | 50 | 500 | | |
| | | 10 x 140 | 50 | 500 | | |
| | | 10 x 160 | 50 | 500 | | |
| 11 250 | Frame-anchor long expansion "RLP" with Pozi-screw, zinc plated   | 10 x 100 | 50 | 500 | | |
| | | 10 x 120 | 50 | 500 | | |
| | | 10 x 140 | 50 | 500 | | |
| | | 10 x 160 | 50 | 500 | | |
| 11 255 | Frame-anchor long expansion "RLPF" with Pozi-screw, hot galvanized   | 10 x 100 | 50 | 500 | | |
| | | 10 x 120 | 50 | 500 | | |
| | | 10 x 140 | 50 | 500 | | |
| | | 10 x 160 | 50 | 500 | | |
| 11 260 | Frame-anchor long expansion "RLT" with Star-screw, zinc plated   | 10 x 100 | 50 | 500 | | |
| | | 10 x 120 | 50 | 500 | | |
| | | 10 x 140 | 50 | 500 | | |
| | | 10 x 160 | 50 | 500 | | |
| 11 265 | Rahmendübel lange Spreizzone "RLTF" with Star-screw, hot galvanized   | 10 x 100 | 50 | 500 | | |
| | | 10 x 120 | 50 | 500 | | |
| | | 10 x 140 | 50 | 500 | | |
| | | 10 x 160 | 50 | 500 | | |
| 11 270 | Frame-anchor long expansion "RLS" with hex-head screw, zinc plated   | 10 x 100 | 50 | 500 | | |
| | | 10 x 120 | 50 | 500 | | |
| | | 10 x 140 | 50 | 500 | | |
| | | 10 x 160 | 50 | 500 | | |
| 11 275 | Frame-anchor long expansion "RLSF" with hex-head screw, hot galvanized   | 10 x 100 | 50 | 500 | | |
| | | 10 x 120 | 50 | 500 | | |
| | | 10 x 140 | 50 | 500 | | |
| | | 10 x 160 | 50 | 500 | | |
| 11 600 | Spacer "LINE"  | red = | 3 | 100 | 4.500 | |
| | | yellow | 5 | 100 | 3.000 | |
| | | blue | 8 | 100 | 2.000 | |
| | | black | 10 | 100 | 1.500 | |
| | | white | 15 | 100 | 1.000 | |

| | | | | | | |
|--------|--|---|-----------|-----|--|--|
| 23 600 | Window frame anchor, counter sunk head "FRST" with star recess T 30 |  | 10 x 72 | 100 | | |
| | | | 10 x 92 | 100 | | |
| | | | 10 x 112 | 100 | | |
| | | | 10 x 132 | 100 | | |
| | | | 10 x 152 | 100 | | |
| | | | 10 x 182 | 100 | | |
| | | | 10 x 202 | 100 | | |
| 23 625 | Window frame anchor, counter sunk head "FRSP" with Pozi 3 recess |  | 10 x 72 | 100 | | |
| | | | 10 x 92 | 100 | | |
| | | | 10 x 112 | 100 | | |
| | | | 10 x 132 | 100 | | |
| | | | 10 x 152 | 100 | | |
| | | | 10 x 182 | 100 | | |
| | | | 10 x 202 | 100 | | |
| 23 650 | Window frame anchor, lens head "FRLP" with Pozi 3 recess |  | 10 x 72 | 100 | | |
| | | | 10 x 92 | 100 | | |
| | | | 10 x 112 | 100 | | |
| | | | 10 x 132 | 100 | | |
| | | | 10 x 152 | 100 | | |
| | | | 10 x 182 | 100 | | |
| | | | 10 x 202 | 100 | | |
| 23 700 | Window frame screw, counter sunk head "FRSS" with star recess T 30 |  | 7,5 x 72 | 100 | | |
| | | | 7,5 x 92 | 100 | | |
| | | | 7,5 x 112 | 100 | | |
| | | | 7,5 x 132 | 100 | | |
| | | | 7,5 x 152 | 100 | | |
| | | | 7,5 x 182 | 100 | | |
| | | | 7,5 x 212 | 100 | | |
| 23 725 | Window frame screw, cylindrical head "FRSZ" with star recess T 25 |  | 7,5 x 72 | 100 | | |
| | | | 7,5 x 92 | 100 | | |
| | | | 7,5 x 112 | 100 | | |
| | | | 7,5 x 132 | 100 | | |
| | | | 7,5 x 152 | 100 | | |
| | | | 7,5 x 182 | 100 | | |
| | | | 7,5 x 212 | 100 | | |
| 23 750 | Window frame screw, round head "FRSR" with star recess T 30 |  | 7,5 x 72 | 100 | | |
| | | | 7,5 x 92 | 100 | | |
| | | | 7,5 x 112 | 100 | | |
| | | | 7,5 x 132 | 100 | | |
| | | | 7,5 x 152 | 100 | | |
| | | | 7,5 x 182 | 100 | | |
| | | | 7,5 x 212 | 100 | | |

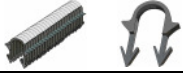
| | | | | | | |
|--------|---|---|----------|-----|-------|--|
| 10 400 | Scaffolding anchor "POWERDRIVE"  |  | 14 x 70 | 25 | 800 | |
| 10 450 | Scaffolding anchor "WALL"  |  | 14 x 70 | 25 | 250 | |
| | | | 14 x 100 | 25 | 250 | |
| | | | 14 x 135 | 25 | 250 | |
| 20 000 | Eyebolt "EYE"  |  | 12 x 90 | 150 | 150 | |
| | | | 12 x 120 | 100 | 100 | |
| | | | 12 x 160 | 100 | 100 | |
| | | | 12 x 190 | 100 | 100 | |
| | | | 12 x 230 | 100 | 100 | |
| | | | 12 x 300 | 50 | 50 | |
| 10 500 | Covercap "KREUZ" transparent, with cross lamella  |  | 14 x 40 | 100 | 2.000 | |
| | | | 14 x 80 | 100 | 2.000 | |
| 10 600 | Covercap "RING" transparent, with ring lamella  |  | 14 x 40 | 100 | 2.000 | |
| | | | 14 x 80 | 100 | 2.000 | |
| 12 000 | Plasterboard anchor "POWER"  |  | | 25 | 5.000 | |
| 12 100 | Plasterboard anchor "INTEGRAL"  |  | | 200 | 2.000 | |
| 24 000 | Plasterboard anchor Metal "EASY"  |  | | 100 | 1.000 | |
| 24 050 | Plasterboard Metal "TOP"  |  | | 200 | 2.000 | |
| 24100 | Metal cavity anchor "MHDS" with pre-assembled screw  |  | 4 x 6 | 100 | 1.000 | |
| | | | 4 x 12 | 100 | 1.000 | |
| | | | 4 x 24 | 100 | 1.000 | |
| | | | 4 x 38 | 100 | 1.000 | |
| | | | 5 x 12 | 100 | 1.000 | |
| | | | 5 x 16 | 100 | 1.000 | |
| | | | 5 x 24 | 100 | 1.000 | |
| | | | 5 x 38 | 100 | 1.000 | |
| | | | 6 x 12 | 100 | 1.000 | |
| | | | 6 x 16 | 100 | 1.000 | |
| 31500 | Cavatiy-anchor plier  |  | | 1 | | |
| | | | | | | |

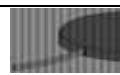
| | | | | | | |
|----------|---|---|-------------|-------------|-------|--|
| 24 600 | Universal metal anchor "UMD" |  | 5 x 30 | 200 | 2.000 | |
| | | | 6 x 32 | 200 | 2.000 | |
| | | | 8 x 38 | 100 | 2.000 | |
| | | | 8 x 60 | 100 | 2.000 | |
| | | | 10 x 60 | 100 | 2.000 | |
| 29 000 | Fast installation steel anchor "FIX-ANKER" zinc plated |  | 6 x 30 | 200 | 2.000 | |
| | | | 6 x 40 | 200 | 2.000 | |
| | | | 6 x 50 | 200 | 2.000 | |
| | | | 6 x 60 | 200 | 2.000 | |
| | | | 6 x 80 | 200 | 2.000 | |
| | | | 6 x 100 | 200 | 2.000 | |
| | | | 8 x 70 | 100 | 1.000 | |
| | | | 8 x 90 | 100 | 1.000 | |
| | | | 8 x 110 | 100 | 1.000 | |
| | | | 8 x 130 | 100 | 1.000 | |
| 8 x 150 | 100 | 1.000 | | | | |
| 8 x 180 | 100 | 1.000 | | | | |
| 29100 | Metal-Insulation-washer "MDS" zinc plated |  | 70 | 100 | 1.000 | |
| 29 200 | Metal-Insulation-anchor "ISO-ANKER" zinc plated |  | 8 x 70 | 100 | 1.000 | |
| | | | 8 x 90 | 100 | 1.000 | |
| | | | 8 x 110 | 100 | 1.000 | |
| | | | 8 x 130 | 100 | 1.000 | |
| | | | 8 x 150 | 100 | 1.000 | |
| 8 x 180 | 100 | 1.000 | | | | |
| 17000 | Insulation anchor "STAR" for soft insulation materials |  | 8 x 60 | 250 | 250 | |
| | | | 8 x 80 | 250 | 250 | |
| | | | 8 x 100 | 250 | 250 | |
| | | | 8 x 120 | 250 | 250 | |
| | | | 8 x 140 | 200 | 200 | |
| 17450 | Insulation anchor "ISOFIX" for polystyrene insulation |  | 10 x 70 | 250 | 250 | |
| | | | 10 x 90 | 250 | 250 | |
| | | | 10 x 110 | 250 | 250 | |
| | | | 10 x 130 | 250 | 250 | |
| | | | 10 x 150 | 250 | 250 | |
| 10 x 180 | 250 | 250 | | | | |
| 15 000 | Tube and cable fixing "KRALLE" Single type |  | 6x70 | 8000 | 8.000 | |
| | | | 8x75 | 3500 | 3.500 | |
| | | | 8x95 | 3000 | 3.000 | |
| | | | 8x110 | 2000 | 2.000 | |
| 15 100 | Tube and cable fixing "KRALLE" Twin type |  | 6x70 | 5000 | 5.000 | |
| | | | 8x75 | 2000 | 2.000 | |
| | | | 8x95 | 1800 | 1.800 | |
| 15 200 | Insulation tube clamp "HOOK" |  | | 100 / 2.500 | 2.500 | |
| 15 300 | Floor radiator tube fixing "ZACK" |  | | 100 | 2.000 | |
| 15 350 | Floor radiator tube fixing "ZACK" on magazine |  | | 50 | 1.500 | |
| 31 000 | Radiator aerating "KEY" |  | | 100 | 1.000 | |
| 16 000 | Nailbound "ROLL" |  | Length 15 m | 10 | 10 | |

SPECIAL PACKAGING

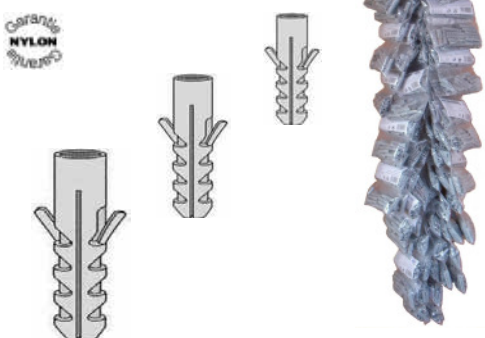
| | | | | | |
|--------|--|-------------------|---|---|--|
| 50 000 | <p>"STRIPPER - NYLON BEST" in a three-chamber polybag 6 mm = 80 pcs. 8 mm = 50 pcs. 10 mm = 25 pcs. 1 stripper presents 30 polybags</p>  | 6 / 8 / 10 | 1 | 1 | |
|--------|--|-------------------|---|---|--|

| | | | | | |
|--------|--|------------------|--|--|--|
| 50 100 | <p>"WALLPLUG - BUCKET"</p>  <p>with 800 plastic wall-plugs "BEST" assortment in a 4-devided bucket 5 mm = 300 pcs. 6 mm = 400 pcs. 8 mm = 100 pcs.</p> | 5 / 6 / 8 | | | |
|--------|--|------------------|--|--|--|

| | | | | | |
|--------|---|---------------|-----|-------|--|
| 11 001 | <p>Screw-nail-anchor "FIX" anchor with countersunk head</p>  | 5 x 30 | 150 | 3.750 | |
| | | 5 x 35 | 140 | 3.500 | |
| | | 5 x 40 | 130 | 3.250 | |
| | | 5 x 50 | 120 | 3.000 | |
| | | | | | |
| | | 6 x 30 | 120 | 3.000 | |
| | | 6 x 35 | 110 | 2.750 | |
| | | 6 x 40 | 100 | 2.500 | |
| | | 6 x 50 | 90 | 2.250 | |
| | | 6 x 60 | 80 | 2.000 | |
| | | 6 x 80 | 60 | 1.500 | |
| | | | | | |

| | | | | | |
|--------|---|---------------|-----|-------|--|
| 11 051 | <p>Screw-nail-anchor "FIX" anchor with cylindrical head</p>  | 5 x 30 | 150 | 3.750 | |
| | | 5 x 35 | 140 | 3.500 | |
| | | 5 x 40 | 130 | 3.250 | |
| | | 5 x 50 | 120 | 3.000 | |
| | | | | | |
| | | 6 x 30 | 120 | 3.000 | |
| | | 6 x 35 | 110 | 2.750 | |
| | | 6 x 40 | 100 | 2.500 | |
| | | 6 x 50 | 90 | 2.250 | |
| | | 6 x 60 | 80 | 2.000 | |
| | | 6 x 80 | 60 | 1.500 | |
| | | | | | |